

THE CUTTING EDGE

KOMET MicroKom *BluFlex*® 2



Precision boring head with integrated high-contrast OLED display and Bluetooth® low-energy wireless technology for connecting to all common Bluetooth®-compatible smartphones from Android™ 4.4 and iOS® 10

BENEFITS for you:

- Display resolution precise to the nearest micrometre: 0.001 mm in diameter
- Unit: mm / inch
- Sophisticated, high-contrast OLED display on the precision adjustment head itself
- Display can be rotated 180°
- Easy to operate on the touch display itself
- Additional Bluetooth® low-energy interface that allows information to be displayed easily on a conventional smartphone
- Higher speeds due to integral part balancing
- Highly sensitive adjustment allows for a precise feed
- Absolute position measuring system – the absolute and relative positions of the slide are displayed at every switch-on
- Universal ABS® interface
- Batteries are easy to replace
- Same construction as the previous version
- Fully compatible with the old system variants



Finger on the pulse of time – The clever alternative: „MicroKom BluFlex“ APP for use as display unit in Google Play™ for Android™ smartphones or the App Store for smartphones running iOS®.

Bluetooth® is a registered trademark of Bluetooth SIG, Inc.
 iOS® is a registered trademark of Cisco Systems, Inc.
 Google Play™ and Android™ are registered trademarks of Google Inc.
 App Store is a trademark of Apple Inc.

KOMET MicroKom *BluFlex*® 2

Variation options

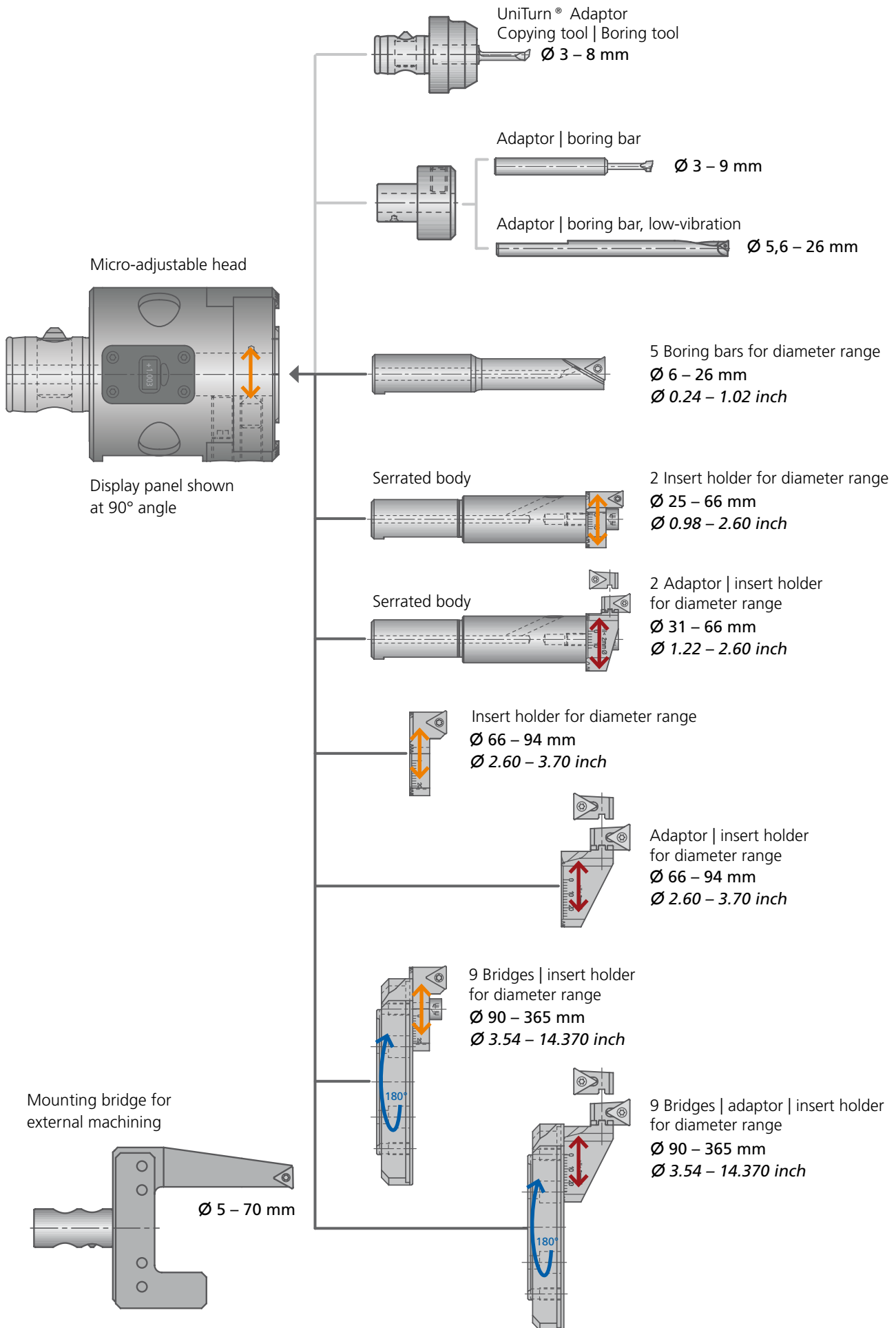

KOMET MicroKom *BluFlex*® 2

Micro-adjustable head

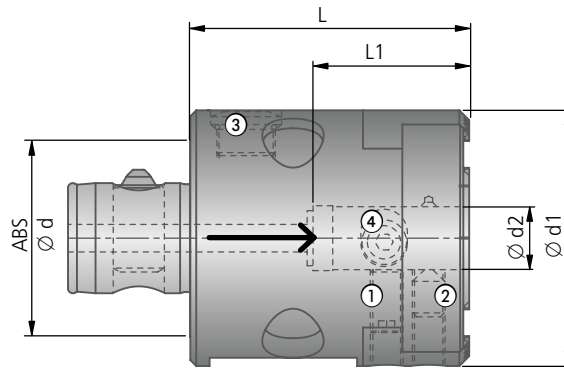
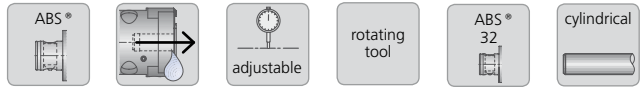



Micro-adjustable head												
Order No.	ABS Ø d	Ø d1	Ø d2	Adjust- ment S	L	L1	kg	Tool clamp:		Battery compartment: Cover/O-ring ③	Slide clamp ④:	
								Clamping screw ①	Clamping screw ②		Clamping screw	Sleeve
								Order No. Article	Order No. Article	Order No.	Order No. Article	Order No.
M04 30100	50	65	ABS32 Ø 16	2,3	71	38	1,45	55051 08120	N00 02062	M04 30000.20 (Ø4) 52914 011315	M04 30000.24 M5×14-Ø4 8 Nm	M04 30000.23
M04 30000								M8×1×20-Ø4	ABS32-F1.1-Ø4			

Adjustment must be in line with cutting parameters and spindle speed.

A radio certification is required for the distribution of radio-enabled devices (M04 30000). This certification for the MicroKom *BluFlex*® 2 currently exists for all CE countries, USA and Canada (FCC). In other countries, only the distribution of the fine adjustment head without Bluetooth® (M04 30100) is permitted.

KOMET MicroKom BluFlex® 2

Fine boring set Ø 6 – 125 mm		Contents of case		
Order No.		Order No.	Qty.	Article
M04 30110	①	M04 30100	1	Micro-adjustable head
M04 30010 	①	M04 30000 	1	Micro-adjustable head Bluetooth®
	②	M05 20101	1	Insert holder Ø 25-44 mm / 0.98"-1.73"
	③	M05 20151	1	Insert holder Ø 44-125 mm / 1.73"-4,92"
	④	M05 80101	1	Bridge Ø 90-125 mm / 3,54"-4,92"
	⑤	M05 90100	1	Serrated body Ø 25-63 mm / 0.98"-2.48"
	⑥	M05 90501	1	Packing piece
	⑦	B05 20100	1	Boring bar Ø 6 mm / 0.236"
	⑧	B05 20140	1	Boring bar Ø 10 mm / 0.394"
	⑨	B05 20180	1	Boring bar Ø 14 mm / 0.551"
	⑩	B05 20220	1	Boring bar Ø 18 mm / 0.709"
	⑪	B05 20260	1	Boring bar Ø 22 mm / 0.866"
	⑫	18050 10030	1	Allen key SW3
	⑬	L05 01110	1	Flag key 5IP
		L05 01120	1	Flag key 6IP
		L05 01240	1	Flag key 8IP
⑭	55011 05016	5	Cylindrical screw M5x16	
	W57 04140.0260	4	Insert BK60	
	W57 14140.0460	4	Insert BK60	
	W00 04120.018440	2	Insert BK8440	
		39924 28021	1	Operating Instructions
		49811 02040	1	Case

Start-up

Press and hold the button to switch on the display.

Press and hold the button to switch between **absolute mode** and **difference mode**.

Pressing the button briefly when in **absolute mode** will take you to the settings.

From here, pressing the button briefly will take you to the next setting, while pressing and holding the button will change the selected setting.

If you are in the last setting („Rotate display“), pressing the button briefly again will take you back to the readings screen.

In **difference mode**, by contract, pressing the button briefly will set the starting point for the difference calculation.

If the device is not operated or the reading does not change, the display will switch itself off.

If Bluetooth® is enabled, the display's automatic switch-off time is extended.

We recommend cleaning the display regularly using a solvent-free glass cleaner.

This will ensure that the display works as it should.

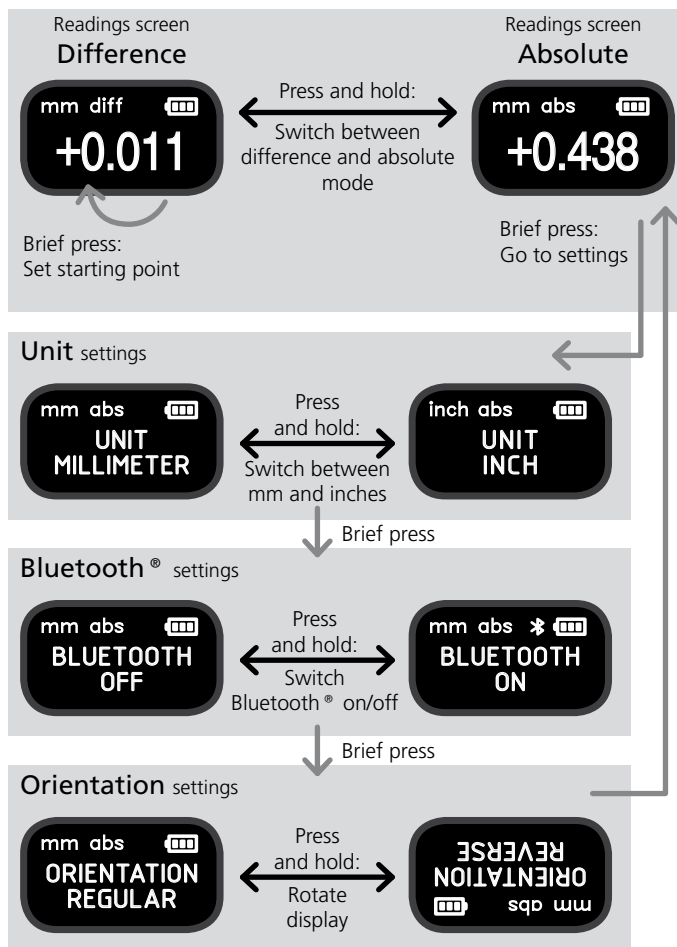

Bluetooth® is a registered trademark of Bluetooth SIG, Inc.